

TU-3A
TU-VIDEO UNIT
SCHEMATIC DIAGRAM(5/8)

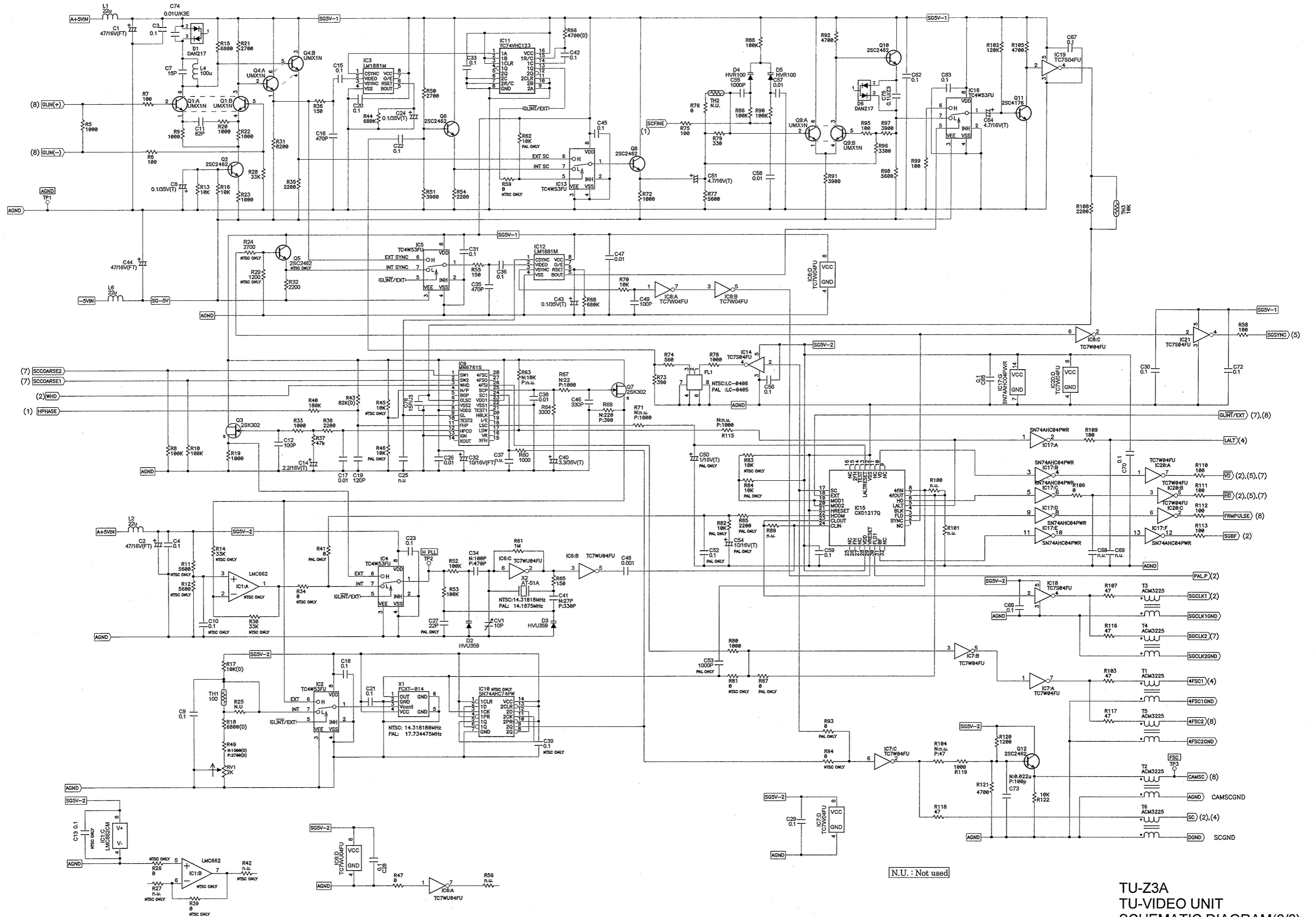

TU-Z3A
TU-VIDEO UNIT
SCHEMATIC DIAGRAM(6/8)

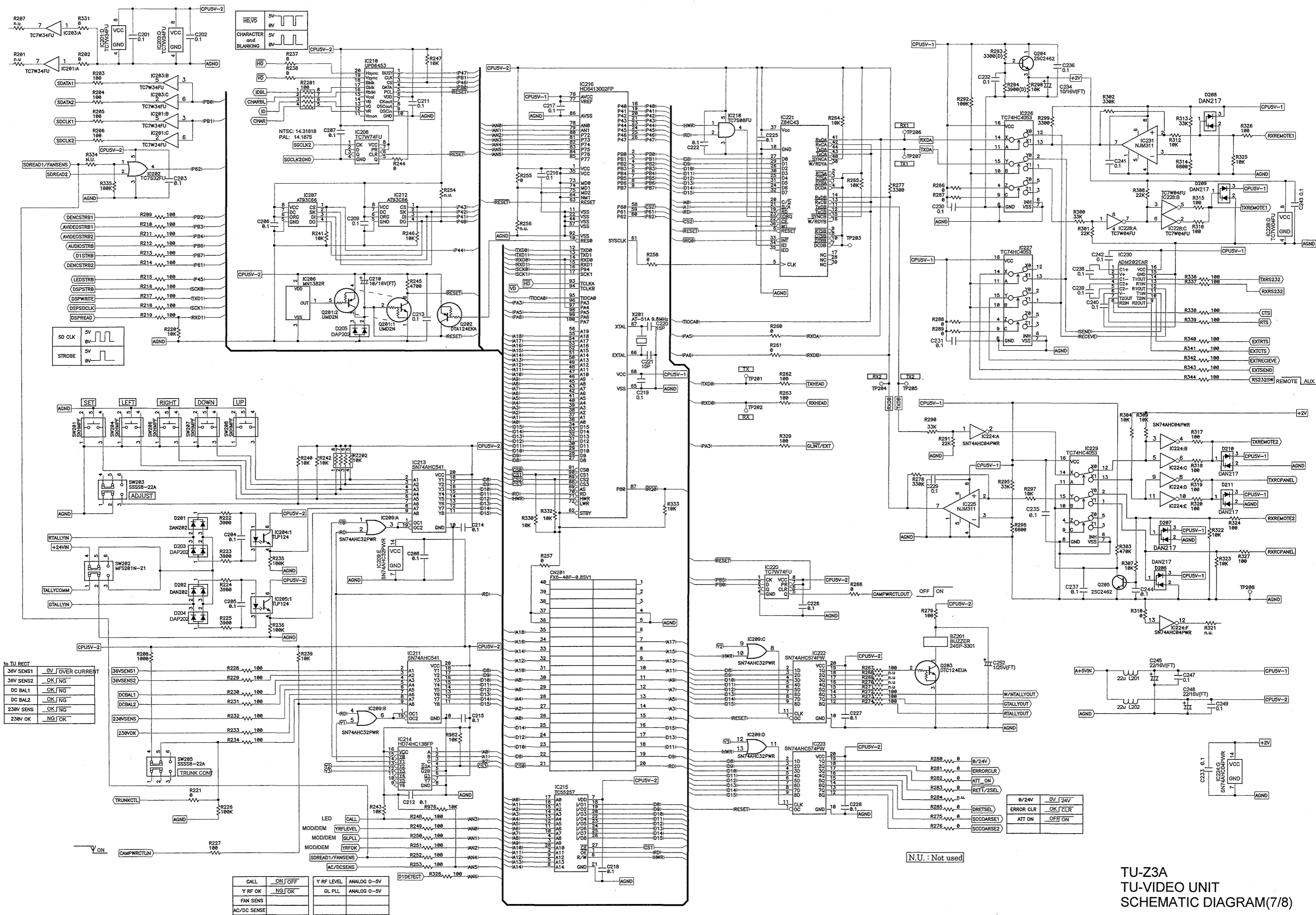

TU-Z3A
TU-VIDEO UNIT
SCHEMATIC DIAGRAM(7/8)

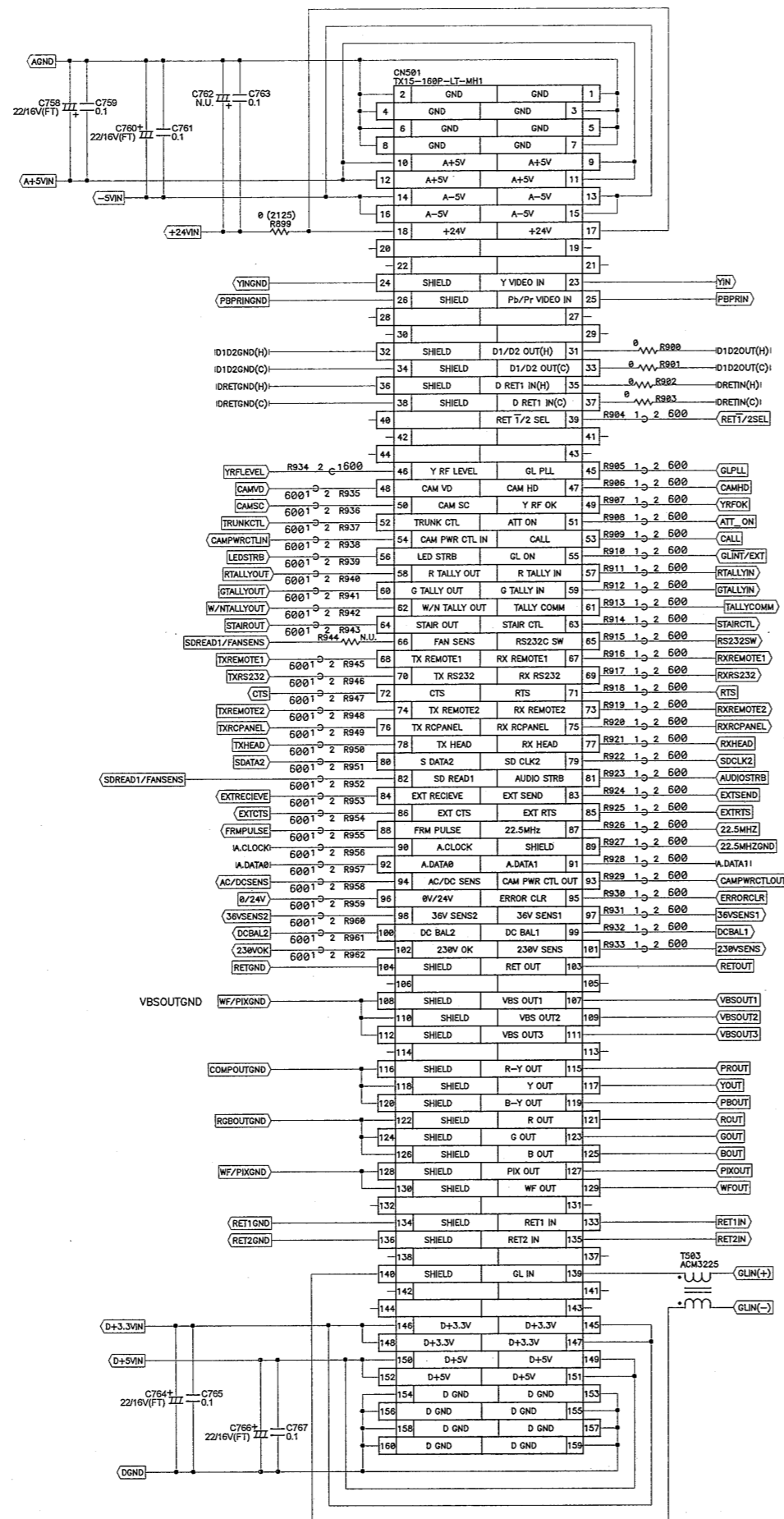

CN503 FX6-48P-0.85V1				
D+3.3VIN	1	D+3.3V	48	D+3.3VIN
D+3.3VIN	2	D+3.3V	39	D+3.3VIN
D+5VIN	3	D+5V	38	D+5VIN
D+5VIN	4	D+5V	37	D+5VIN
DGND	5	D GND	36	DGND
DGND	6	D GND	35	DGND
A+5VIN	7	A+5V	34	A+5VIN
-5VIN	8	A-5V	33	-5VIN
AGND	9	A GND	32	AGND
D1STRB	10	D1 STRB	31	D1STRB
D1DETECT	11	D1 DETECT	30	D1RST
DRETIN(H)	12	D RET(H)	29	DRETGND(H)
DRETIN(C)	13	D RET(C)	28	DRETGND(C)
ISCLK2	14	SD CLK2	27	SDATA2
DRETVIDEO	15	D RET VIDEO	26	DRETVIDEOGND
A.CLOCK	16	A.CLOCK	25	
A.DATAB	17	A.DATAB	24	A.DATAB
D1D2OUT(H)	18	D1/D2 OUT(H)	23	D1D2GND(H)
D1D2OUT(C)	19	D1/D2 OUT(C)	22	D1D2GND(C)
	20		21	

N.U. : Not used

TU-3A
TU-VIDEO UNIT
SCHEMATIC DIAGRAM(8/8)

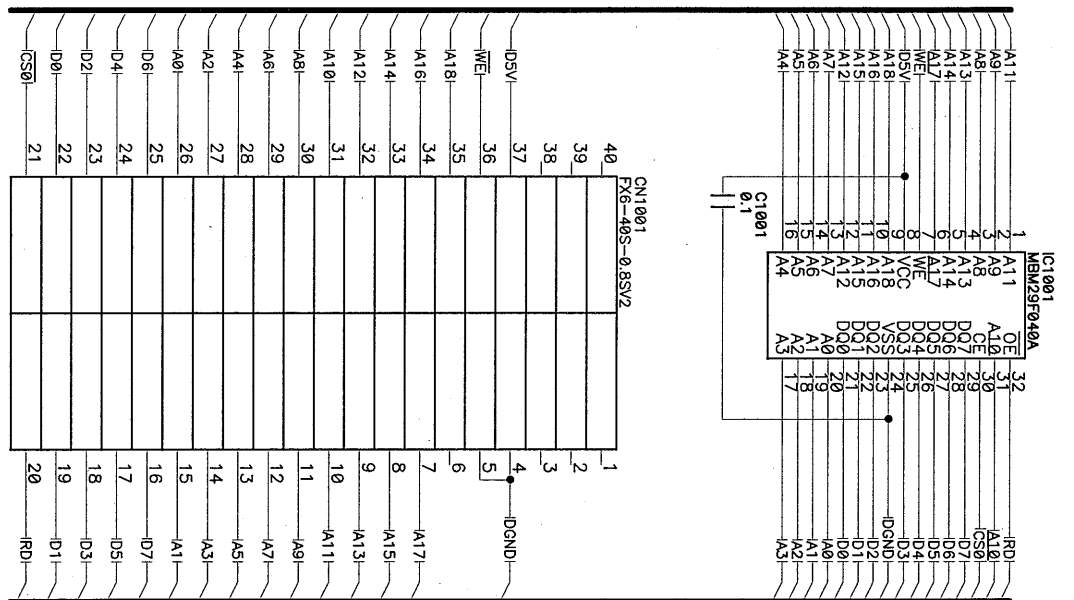

TU-Z3A
MEMORY UNIT
SCHEMATIC DIAGRAM

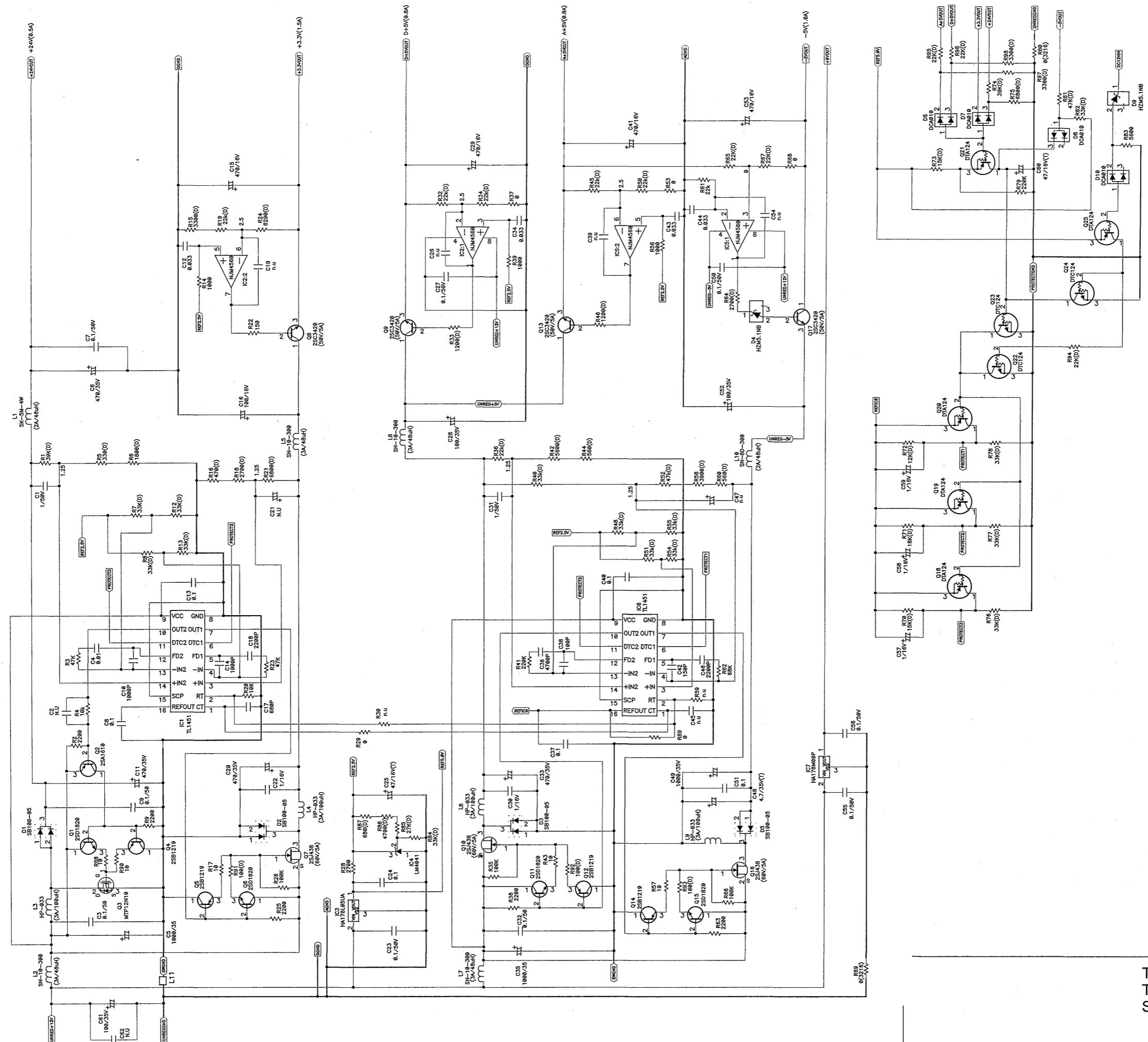

TU-Z3A
TU-PWR/INCOM UNIT(POWER)
SCHEMATIC DIAGRAM(1/2)

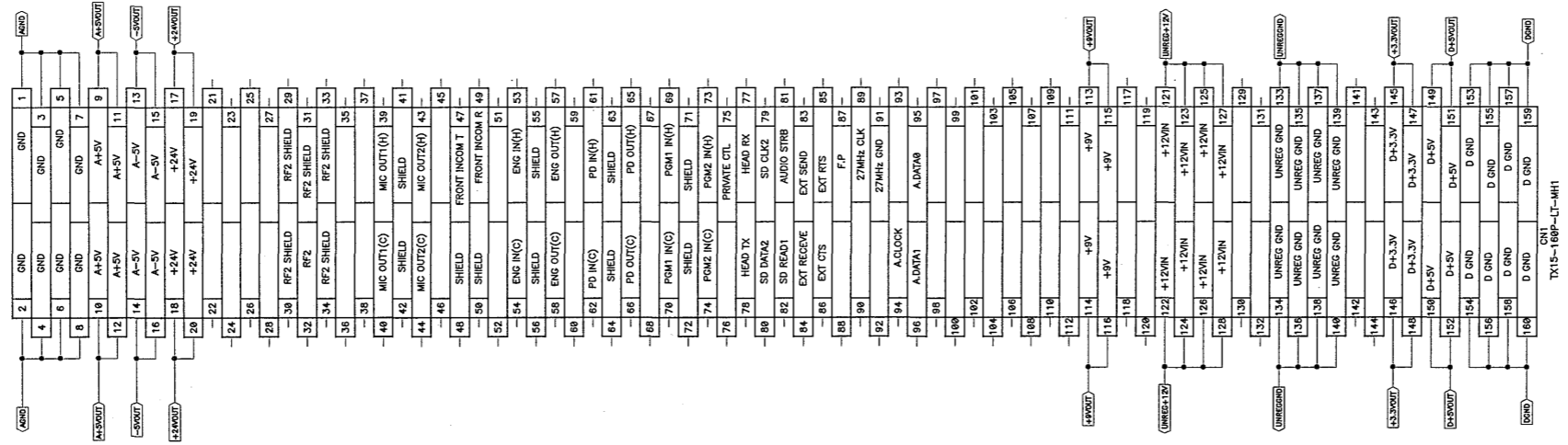

TX15-168P-LT-MH1

TU-Z3A
TU-PWR/INCOM UNIT(POWER)
SCHEMATIC DIAGRAM(2/2)

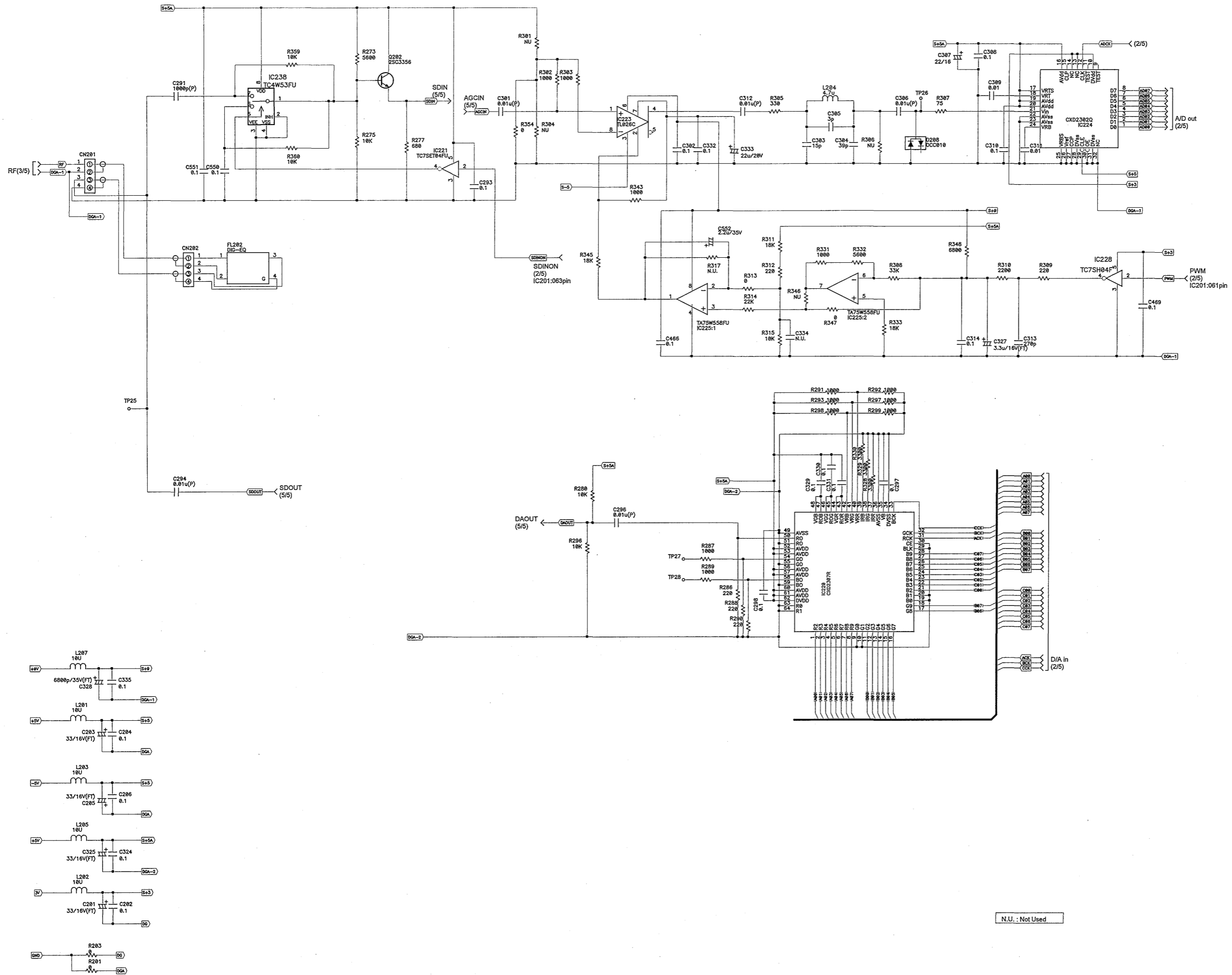

N.U. : Not Used

TU-Z3A
TU-PWR/INCOM UNIT(INCOM)
SCHEMATIC DIAGRAM(1/5)

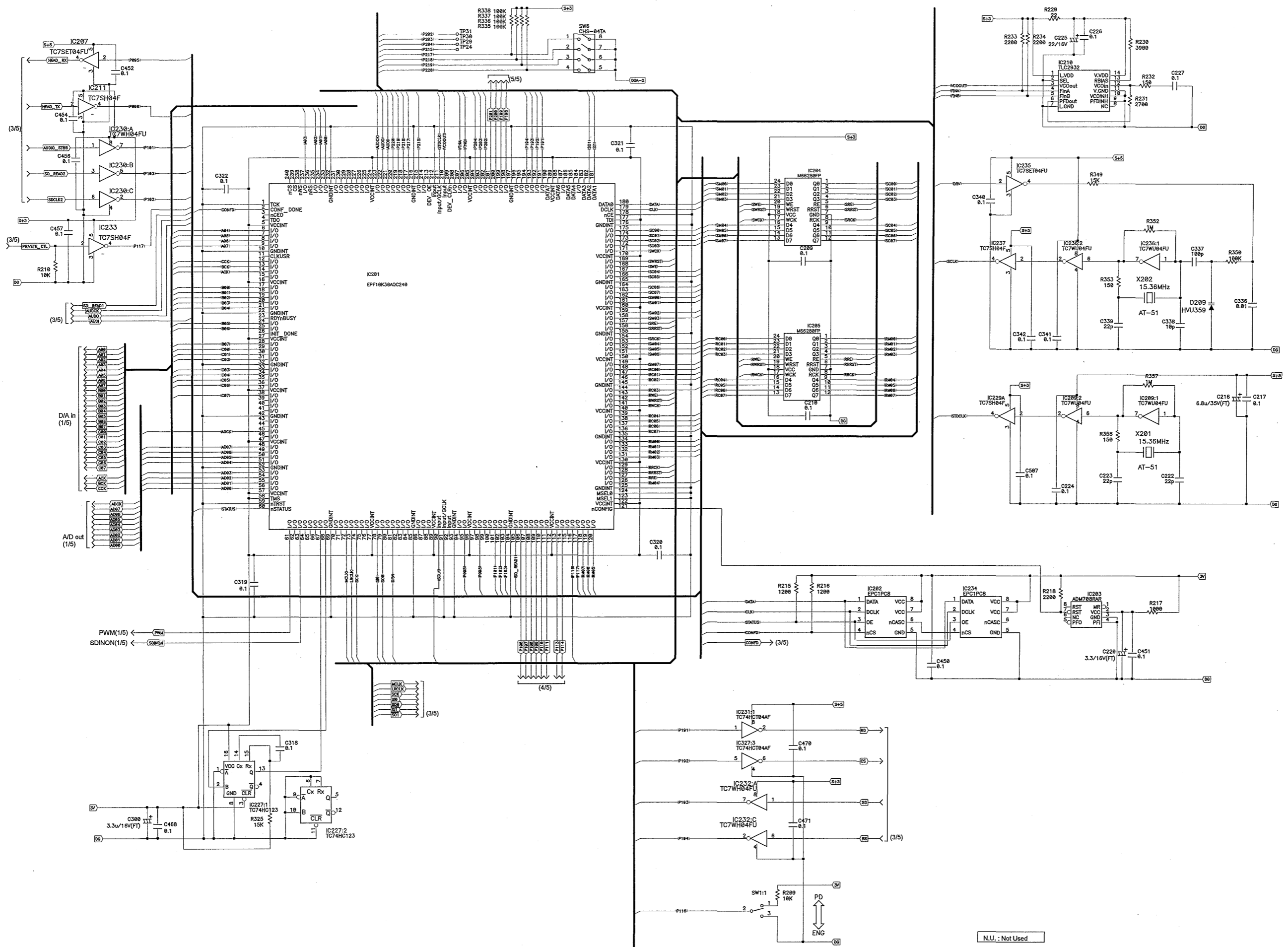

TU-Z3A
TU-PWR/INCOM UNIT(INCOM)
SCHEMATIC DIAGRAM(2/5)